



# d-ball **UP**

---

ELECTRONIC BALL EJECTOR

User guide

---



---

EN

**Declaration of conformity**

**Manufacturer:**

VNT electronics s.r.o.

Dvorská 605

563 01 Lanškroun

ID No.: 64793826

declares that the following product:

**Electronic ball ejector**

**Dogtrace d-ball UP**

is in accordance with European Council Directive 1999/5/EC of 9 March 1999, meets the requirements of the Czech Telecommunication Office's General License pursuant to General Authorization No. VO-R/10/05.2014-3m, and corresponds to the below-mentioned requirements of the standards and regulations applicable to the type of equipment concerned:

**ETSI EN 301 489-1 V1.9.2**

**ETSI EN 301 489-3 V1.6.1**

**ETSI EN 300 220-2 V.2.4.1**

**ETSI EN 60950-1: 2006**



The product is safe under conditions of standard use in accordance with the user guide. This declaration of Conformity is created in exclusive responsibility of producer.

In Lanškroun 1. 6. 2017

Ing. Jan Horák

executive director

Tel.: +420 461 310 764

info@dogtrace.com

**www.dogtrace.com**

A handwritten signature in black ink, appearing to be 'J. Horák', written over the printed name and title.

Thank you for purchasing the product **d-ball UP** of the trademark **Dogtrace** from **VNT electronics s.r.o.**, Czech Republic.

Before using your product, please read the instructions in this user guide carefully and keep it for future reference.

Hereby, **VNT electronics s.r.o.**, declares that this **Dogtrace d-ball UP** is in compliance with the essential requirements and other relevant provisions of Directive 1999/5/EC.

## Important notices

- Read the operating instructions before using the **d-ball UP** ejector.
- **Do not insert your fingers or other part of the body into the hole intended for the ball – THIS MAY CAUSE SERIOUS INJURY!**
- Load the ejector only with balls.
- The ball ejector can be operated only by persons over 18 years of age.
- Do not place the transmitter near objects sensitive to magnetic fields as this may cause their permanent damage.
- Batteries in the receiver and transmitter must be replaced every two years, even if the kit has not been used for a long time. Never leave a discharged battery in the device – it could damage your device.
- Used batteries must be disposed in a place designated for this purpose.
- Persons with devices supporting cardiac activity (pacemakers, defibrillators) must take appropriate precautions. D-ball UP radiates a certain static magnetic field.

## ECMA



**VNT electronics s.r.o.**, professional producer of the dog training equipment, which is manufactured and sold under the brand name Dogtrace, is a proud and active member of the **Electronic Collar Manufacturers Association**.

ECMA was founded in Brussels in 2004 as a result of increasing awareness from different manufacturers concerning the necessity of regulating their industry. The main target of the association is to develop and produce reliable training systems of high quality, which are safe for the animals and improve the communication between pets and their owners. All members of the ECMA provide you with both technical and training guides that contain instructions and advice for safe use of electronic training equipment and enable all dog owners to use the training systems in an effective, responsible and humane way. All ECMA member's products meet the latest technical requirements which ensure minimum production standards and safety features and enable training while protecting animal welfare.

The ECMA is convinced that the electronic training collars are effective and humane training tools when used responsibly and combined with an appropriate reward.

For more information please visit [www.ecma.eu.com](http://www.ecma.eu.com).

## Contents

Introduction .....	5
Package contents .....	5
Optional accessories .....	5
Product description .....	6
Transmitter .....	6
Ball ejector .....	7
Transmitter preparation .....	8
Insertion (replacement) of the battery in the transmitter .....	8
Checking the state of the battery in the transmitter .....	8
Preparing the ejector .....	8
Insertion (replacement) of the batteries in the ejector .....	8
Checking the state of the batteries in the ejector .....	9
Switching ON/OFF .....	9
Pairing the transmitter with the ejector .....	10
D-ball UP control .....	10
Features of the transmitter .....	11
Maximum range of the transmitter .....	11
Troubleshooting .....	12
Maintenance .....	12
Technical data .....	13
Warranty terms and conditions .....	14
Warranty certificate .....	16

## Introduction

**D-ball UP** is a remote-controlled ejector of balls that serves for training of service dogs, agility and regular training. D-ball UP is a great tool especially for training tracks. Expectation of a "live" reward in the form of a shot ball motivates the dog to fulfil tasks faster, more precisely and with joy. After each exercise, the dog will receive the reward only if he deserves it.

The ball is ejected from the device by means of a remote transmitter at a distance of up to 200 m and up to a height of 3 m. If the ejector is fastened upright with the included strap or supported by the metal support in an inclined position, the range can be up to 6 m. Low profile of the d-ball UP (105 mm) allows easy camouflage. The transmitter can control up to 4 ejectors and can be combined with ball feeders d-ball. The system is suitable for training centres and home use.

### Package contents

- Transmitter
- Ball ejector
- Lithium battery CR2 3V
- alkaline batteries AA 1,5V - 4 pcs
- Strap for hanging the ejector
- Ball
- Pins for attaching the ejector to the ground - 2 pcs
- Metal support – ejecting the ball in the distance
- Lanyard
- User guide and certificate of warranty

### Optional accessories

- Spare transmitter and ball ejector
- Spare battery
- Spare balls (different types)

## Product description

### Transmitter

1. Indicators
2. Acoustic signal buttons for ejector 1 to 4
3. Ball ejection buttons for ejector 1 to 4
4. Neck strap hole
5. Battery compartment cover

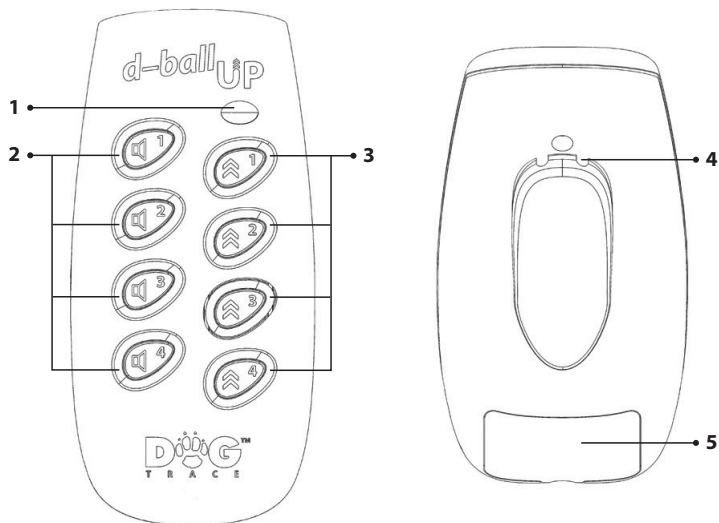

## Ball ejector

1. Space for inserting the ball
2. Holes for pins attaching the ejector to the ground
3. Eyelet for lacing the strap to hang the ejector
4. Indicators
5. Target – a place for applying the magnet – switching on/off
6. Battery compartment cover
7. Holes for inserting the metal support

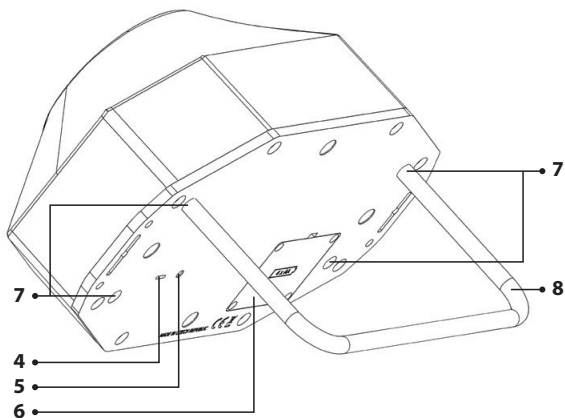
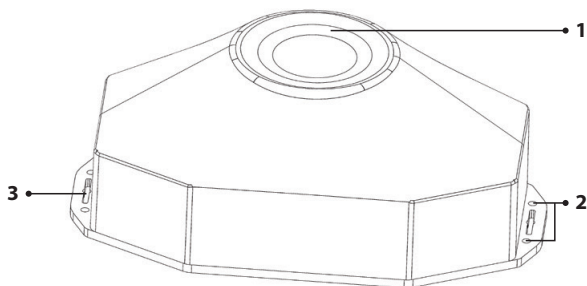

## Transmitter preparation

### Insertion (replacement) of the battery in the transmitter

1. Unscrew the screw on the back of the battery compartment cover using a cross-head screwdriver and open the cover carefully.
2. Insert the CR2 3V battery correctly regarding its polarity. The polarity is indicated in the battery compartment (see the photo).
3. Insert the battery compartment cover back into its position and tighten its screw with adequate force.
4. When the battery is inserted, the transmitter is always in the standby mode.

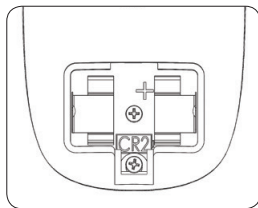

### Checking the state of the battery in the transmitter

Discharged battery is indicated by the red indicator when any button is pressed. When the battery becomes low, the transmitter performance (radio range) is reduced. If the battery is discharged, insert a new CR2 3V lithium battery into the transmitter. After changing the battery, it is necessary to press twice any button on the transmitter for correct battery indication.

**TIP:** The battery can be removed easily when using a small screwdriver inserted carefully under the battery edge.

## Preparing the ejector

### Insertion (replacement) of the batteries in the ejector

1. Unscrew the four screws of the battery compartment cover on the bottom side of the ejector (indicated by the battery symbol) using a cross-head screwdriver.
2. Push the battery holder out.
3. Insert four AA alkaline batteries correctly regarding their polarity (polarity is indicated on the battery holder).
4. Push the battery holder back – the battery holder must be correctly rotated (see the figure).
5. Check the rubber seal in the slot of the battery compartment cover for correct placement. Take care of the seal cleanness.
6. Insert the battery compartment cover back into its position and tighten all four screws with adequate force.

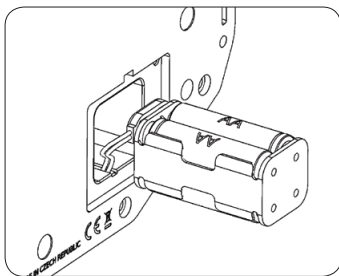



## Checking the state of the batteries in the ejector

The state of the batteries is checked by flashing indicators on the bottom side of the ejector.

- **Charged battery** – the green indicator flashes when the ejector is switched on.
- **Low battery** – the green and red indicator flashes simultaneously when the ejector is switched on.

If the batteries are discharged, insert new alkaline AA batteries into the ejector.

## Switching ON/OFF

To switch on/off the ejector, a magnetic switching system is used. The system is activated by attaching a magnet. The magnet is attached at the bottom part of the transmitter.

### Switching on:

1. Attach the bottom part of the transmitter to the red round target on the bottom side of the ejector – the red indicator and then the green indicator will turn on.
2. Take the transmitter away from the ejector when the green indicator is on. The green indicator will start flashing.

### Switching off:

1. Attach again the bottom part of the transmitter to the red round target on the bottom side of the ejector – the green indicator and then the red indicator will turn on.
2. Take the transmitter away from the ejector when the red indicator is on. The indicators will stop flashing.

**Important:** When switching on the ejector, it is enough to attach the transmitter to the red target of the ejector for approximately 1 second. If you hold the transmitter at the target for more than 5 seconds, the receiver enters the mode of pairing the transmitter with the ejector. If this happens, follow the chapter *“Pairing the transmitter with the ejector”* on pg.10.

**CAUTION:** To extend the battery life, the ball feeder must always be turned off after training. We recommend removing the battery completely if you do not use the ball feeder for a long time.

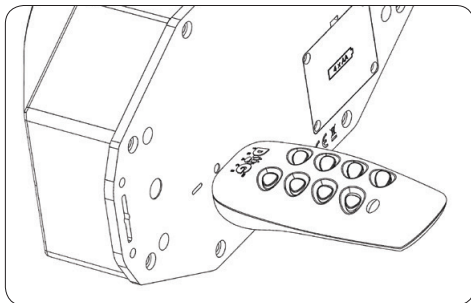

## Pairing the transmitter with the ejector

Each transmitter has its radio operating codes. The transmitter communicates with your ejector only after mutual pairing. When buying a new set, the transmitter is paired with the ejector. Pairing is necessary if you want to pair other ejectors or ball feeders with your transmitter.

**Important:** Before pairing the transmitter and ejector, make sure that no one else uses his/her d-ball in your vicinity. Your ejector could receive the code of another transmitter. Your ejector would then be controlled by someone else. If this happens, pair your ejector with your transmitter.

### Pairing procedure

Switch off the ball ejector before starting pairing (no indicator flashes).

**Do not load the ejector before pairing – risk of injury.**

1. Attach the bottom side of the transmitter to the red target on the bottom side of the ejector for 5 seconds. The red indicator and then the green indicator will turn on.
2. After 5 seconds, both indicators will flash three times at the same time.
3. Take the transmitter away from the ejector.
4. **Press the acoustic signal button**  **on the transmitter** (position 1 to 4 depending on which position you want to pair with the given ejector).
5. Successful pairing is indicated by a long beep of the ejector.

## D-ball UP control



### Loading the ejector

1. Place the ball on the launching bowl
2. Push the ball by your palm to the bottom of the ejector

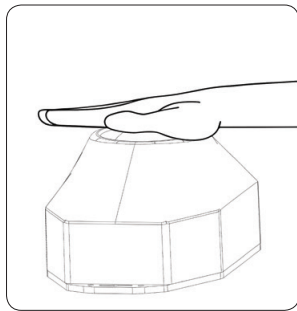
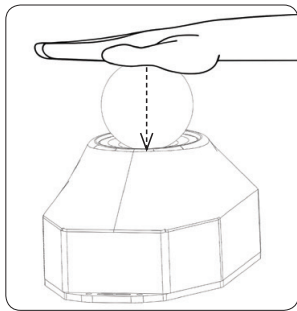
**CAUTION:** Load the ejector with balls only. Do not insert your fingers or other part of the body into the loaded ejector – this may cause serious injury. The ball ejector can be operated only by persons over 18 years of age.



## Features of the transmitter

The d-ball UP transmitter allows you to control 4 ball ejectors or ball feeders (buttons numbered 1 to 4). After pressing the  button, the ejector will emit an acoustic signal. This function serves to alert the dog to the place where his reward in the form of ejected ball is to be expected. The ball is launched from the ejector by pressing the  button. The ball ejection height is up to 3 m (depending on the weight of the ball used). It is possible to use any ball up to the diameter of 75 mm. The ejector can be hung upright or supported by the metal support to eject balls away. The ball can be ejected to the distance up to 6 m.

## Maximum range of the transmitter

The d-ball UP kit can be used up to 200 m. However, the maximum range is influenced by a number of factors – weather, terrain, vegetation, etc.

To ensure maximum range of your device:

- Do not cover the antenna at the top of the transmitter.
- When transmitting the command, hold the transmitter in the vertical position away from the body and in the extended arm over your head.
- Check the battery in the transmitter and receiver; replace it when necessary.

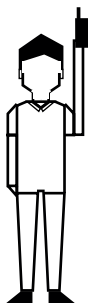

*maximum range*

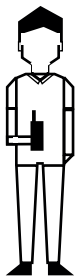

*regular range*

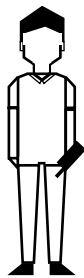

*minimum range*

## Troubleshooting

1. Read these operating instructions again and check whether the problem is not caused by low batteries or improper use.
2. Make sure that the batteries are inserted with the correct polarity.
3. If the transmitter does not communicate with the ejector, try to pair devices again (see chapter – *Pairing the transmitter with the ejector* on pg. 10).
4. If the launching bowl gets jammed in the bottom position (dirt around the launching bowl), turn the ejector upside down and tap the ground slightly with it. This will result in removing any dirt around the launching bowl and the bowl will get unblocked.
5. Contact your seller if the problem persists.

## Maintenance

Do not use volatile substances such as solvents, petrol or other cleaners to clean your d-ball UP. Use a soft damp cloth and, if necessary, also a neutral detergent.

The transmitter is only resistant to dripping water – protect it from moisture. Permanent damage may occur if moisture penetrates inside the unit. This damage is not covered by the warranty.

The ejector contains waterproof electronics and battery. Protect the ejector from heavy rain. If the water enters the ejector, the launching motor can be damaged and the springs may corrode. Ensure that the seal in the battery compartment cover is not damaged or dirty – it may cause moisture penetration. Check that the battery compartment cover screws are tightened.

Remove batteries from the transmitter and ejector if you do not use your d-ball UP over a longer period.

## Technical data

### Transmitter

Range .....	200 m (direct visibility)
Power supply .....	lithium battery CR2 3V
Battery life .....	6–12 months depending on usage
Frequency .....	869.525 Mhz
Antenna .....	integrated
Protection .....	not waterproof
Operating temperature .....	–10°C up to +50°C
Weight .....	61 g (without the battery)
Dimensions .....	110 × 52 × 29 mm

### Ejector

Ejection height .....	up to 3 m (depending on the ball weight)
Ejection distance .....	up to 6 m (depending on the ball weight and ejection angle)
Maximum ball diameter .....	75 mm
Power supply .....	4 alkaline batteries AA; 1,5V
Battery life .....	6 months depending on usage
Antenna .....	integrated
Protection .....	not waterproof
Operating temperature .....	–10°C up to +50°C
Weight .....	810 g
Dimensions .....	255 × 105 × 140 mm

## Warranty terms and conditions

In the event of a manufacturing defect, the company **VNT electronics s.r.o.** provides a warranty for the product for a term of two years from the purchase.

The warranty does not cover the following items:

- Batteries
  - Strap with eyes for hanging
  - Direct or indirect risks during product transport to the seller
  - Damage to the product due to user negligence or accident (e.g. mastication, breaking, impact, etc.) and intervention of unauthorized persons.
1. The warranty period begins with the buyer's receipt of the goods. The condition for lodging a complaint at the seller is the submission of the confirmed warranty certificate or a proof of purchase. The full terms and conditions are available at: **www.dogtrace.com**.
  2. The warranty provided does not apply to product defects that originated due to:
    - a) improper installation or failure to observe the instructions from the manufacturer's manual.
    - b) improper use of the product.
    - c) inappropriate storage or care of the product.
    - d) unauthorized interference or repairs performed without the manufacturer's knowledge.
    - e) natural disaster or other inescapable event.
    - f) change of the goods made by the consumer if such a change results in damage or effect of the goods.
    - g) mechanical damage by the consumer.
    - h) other actions of the consumer that would conflict with these warranty conditions or instructions for use.
  3. The warranty cannot be claimed unless the goods have been fully paid or if the goods are from clearance.
  4. The complainant is required to prove the product defect, to allow the manufacturer to verify the eligibility of the product defects claim and to assess the extent of the defects. At the same time, he/she is obliged to hand over the product in a condition allowing the assessment of defects. The complainant is not authorized to repair the product by himself/herself or through a third party. Otherwise, he/she will lose entitlements arising from the manufacturer's liability for product defects.
  5. Consumer's claims arising from the manufacturer's liability for product defects are governed by general legal regulations. In the case of proven manufacturing defects, the manufacturer is obliged to replace the faulty product for faultless.
  6. Goods submitted for reclamation must be properly cleaned. The complaints department is entitled to refuse the goods for the complaint procedure if the general hygiene principles are not observed.
  7. If the product is sent for the complaint procedure by post or shipping company, it must be packed in a sufficient manner and secured against damage. For these purposes, we recommend keeping the original packaging (not a condition for receiving a complaint).
  8. For shipping, choose the most convenient way and carrier with regard to delivery availability and speed. We are not liable for the loss of the goods that you ship.
  9. Other rights and obligations of the manufacturer and the persons entitled to lodge a complaint are regulated by the relevant generally binding legal regulations of the Czech Republic.

*The information contained in this manual may be subject to change due to developments without further notice.*

